

WESTWOOD DESIGN

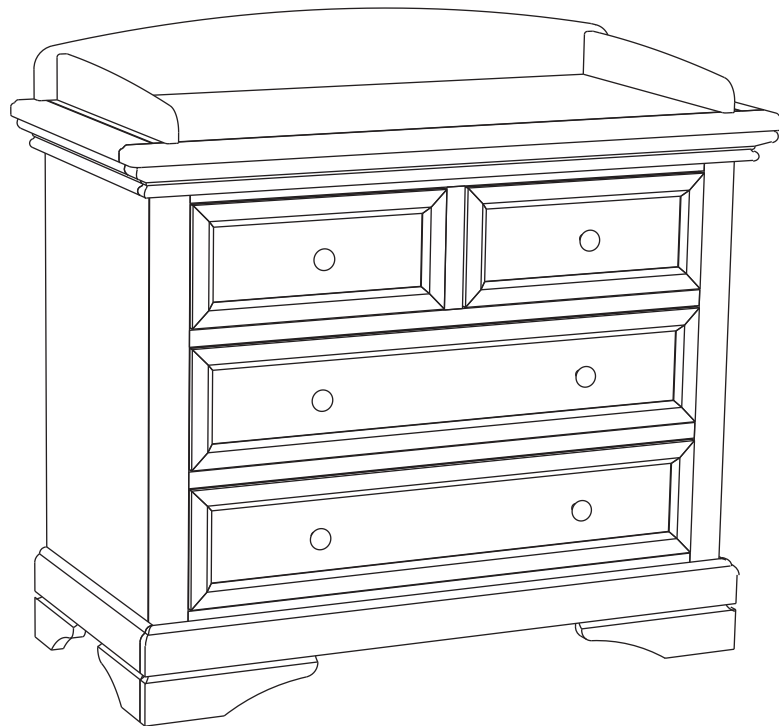

Assembly Instructions
Waverly Dressing Combo



WARNING: FALL HAZARD



- **TO PREVENT DEATH OR SERIOUS INJURY, ALWAYS KEEP CHILD WITHIN ARM'S REACH.**
- THIS PRODUCT IS NOT INTENDED TO BE USED AS A CHANGING TABLE UNLESS EQUIPPED WITH AN APPROVED CHANGING PAD THAT MEETS ASTM F2388-06. USE OF THE PRODUCT WITHOUT THIS MAY RESULT IN DEATH OR SERIOUS INJURY TO YOUR CHILD FROM FALLING.
- THE MAXIMUM WEIGHT OF THE OCCUPANT MAY NOT EXCEED 30 LBS. (13.6 kg).
- THE CHANGING PAD MAY NOT EXCEED 44 IN. (1115 mm) IN LENGTH OR 18 IN. (455 mm) IN WIDTH.
- THE CHANGING PAD **MUST** BE SECURED TO THE CHANGING SURFACE FOLLOWING THE PAD MANUFACTURER'S INSTRUCTIONS.
- READ ALL INSTRUCTIONS BEFORE USE OF THE CHANGING TABLE OR THE CHANGING PAD.
- DO NOT USE CHANGING TABLE OR CHANGING PAD IF BROKEN.
- KEEP ALL INSTRUCTIONS FOR THE FUTURE.

Congratulations on your purchase of a Westwood product. We take great pride in the quality and design of our furniture. The safety of your child is our highest priority. It is important that you read these instructions carefully and completely to ensure that this product functions as it was designed.

After opening the package, check to see that all the parts are present. If you think something is missing, please contact your retailer, and they can arrange to have the missing parts quickly replaced. You can also contact us directly, by calling 1-973-305-0444, or emailing support@westwoodbaby.com.

If any aspect of these instructions is unclear, please contact your retailer or Westwood Design for assistance.

Parts Included in Package:

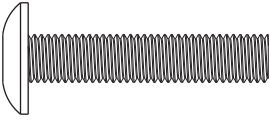
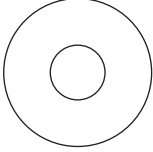
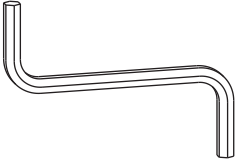
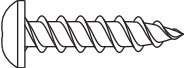
A Galley Rail Back 	B 2 x Galley Rail Side 	
C 4 x Allen Head Bolt 	D 4 x Nylon Washer 	E Allen Wrench 
F 4 x Wood Screw 		

Step 2

- A.** Align the holes in the galley rail sides (B) with the holes in the galley rail back (A).
- B.** Place a nylon washer (I) onto a bolt (H), then thread it through the hole. Tighten securely using the allen wrench (J). Repeat for the other hole.
- C.** Repeat for the other galley rail side.
- D.** If you are using a changing pad, secure it to the combo using the straps as instructed by the pad manufacturer.
- E.** Center the galley rail on the top, then screw the wood screws (I) through the holes on the mounting plates and into the combo.

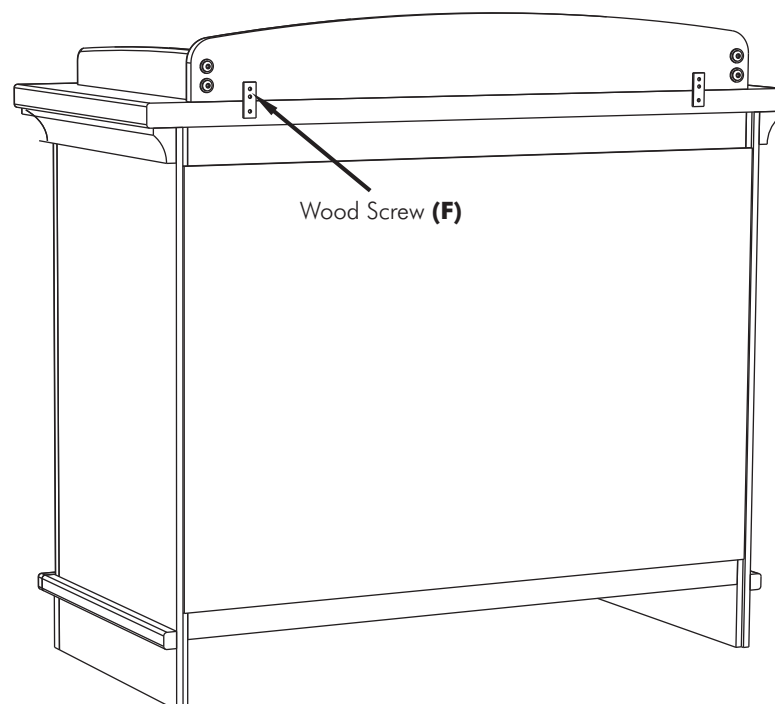
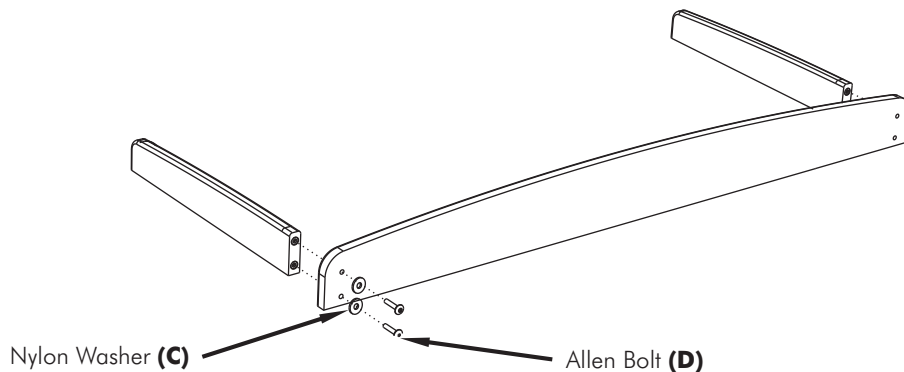

WESTWOOD DESIGN

635 N. Billy Mitchell Rd., Ste. B
Salt Lake City, UT 84116 USA
Phone: 1-973-305-0444
support@westwoodbaby.com