

# H Hart Furniture



## **Assembly Instructions** **Meadowdale Dressing Combo**



## **WARNING: FALL HAZARD**

- **TO PREVENT DEATH OR SERIOUS INJURY, ALWAYS KEEP CHILD WITHIN ARM'S REACH.**
- THIS PRODUCT IS NOT INTENDED TO BE USED AS A CHANGING TABLE UNLESS EQUIPPED WITH AN APPROVED CHANGING PAD THAT MEETS ASTM F2388-06. USE OF THE PRODUCT WITHOUT THIS MAY RESULT IN DEATH OR SERIOUS INJURY TO YOUR CHILD FROM FALLING.
- THE MAXIMUM WEIGHT OF THE OCCUPANT MAY NOT EXCEED 30 LBS. (13.6 kg).
- THE CHANGING PAD MAY NOT EXCEED 44 IN. (1115 mm) IN LENGTH OR 18 IN. (455 mm) IN WIDTH.
- THE CHANGING PAD **MUST** BE SECURED TO THE CHANGING SURFACE FOLLOWING THE PAD MANUFACTURER'S INSTRUCTIONS.
- READ ALL INSTRUCTIONS BEFORE USE OF THE CHANGING TABLE OR THE CHANGING PAD.
- DO NOT USE CHANGING TABLE OR CHANGING PAD IF BROKEN.
- KEEP ALL INSTRUCTIONS FOR THE FUTURE.

**Congratulations on your purchase of a Hart product. We take great pride in the quality and design of our furniture. The safety of your child is our highest priority. It is important that you read these instructions carefully and completely to ensure that this product functions as it was designed.**

**After opening the package, check to see that all the parts are present. If you think something is missing, please contact your retailer, and they can arrange to have the missing parts quickly replaced. You can also contact us directly by calling 1-908-719-4707.**

**If any aspect of these instructions is unclear, please contact your retailer or Hart Furniture for assistance.**

## Parts Included in Package:

**A** Galley Rail Back



**B** 2 x Galley Rail Side



**C** Shelf

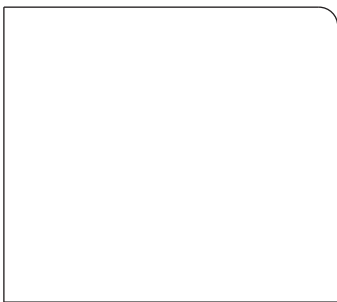

**D** 4 x Shelf Tab

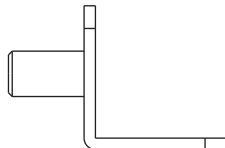

**E** 4 x Removable Foot



**F** 4 x Phillips Head Bolt

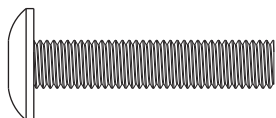

**G** 4 x Wood Screw

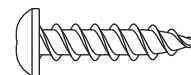

## Step 1

- A.** Unpack all the components from the packaging.  
The feet are located in the top left drawer.
- B.** Screw the removable feet into the base.

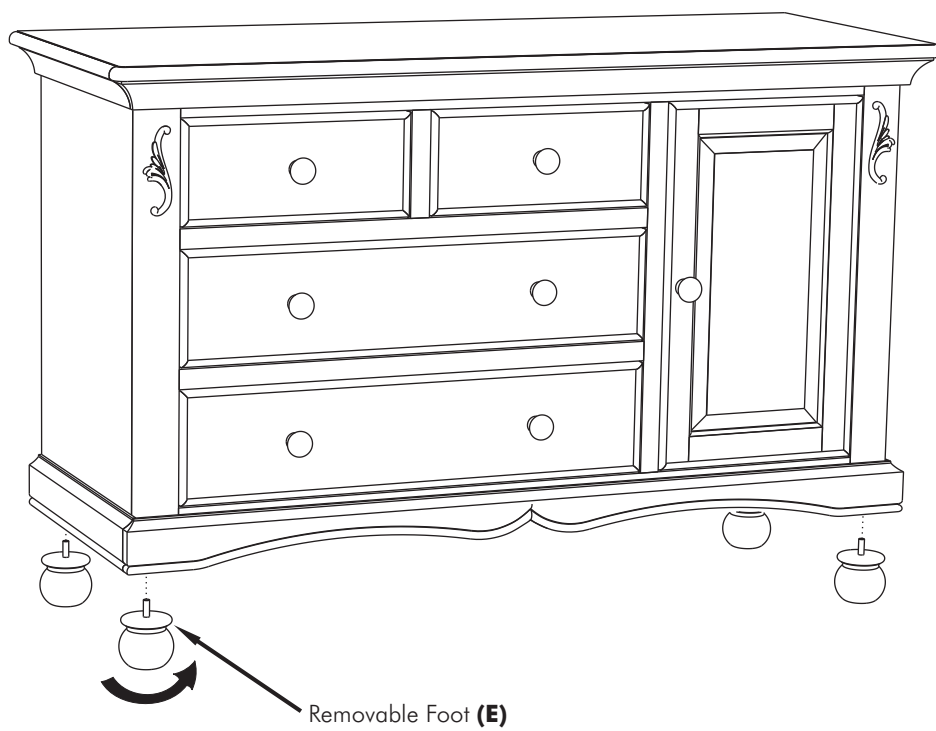

## Step 2

- A.** Align the holes in the galley rail sides (B) with the holes in the galley rail back (A).
- B.** Thread a bolt (F) through the hole. Tighten securely using a phillips head screwdriver, and repeat for the other hole.
- C.** Repeat for the other side.

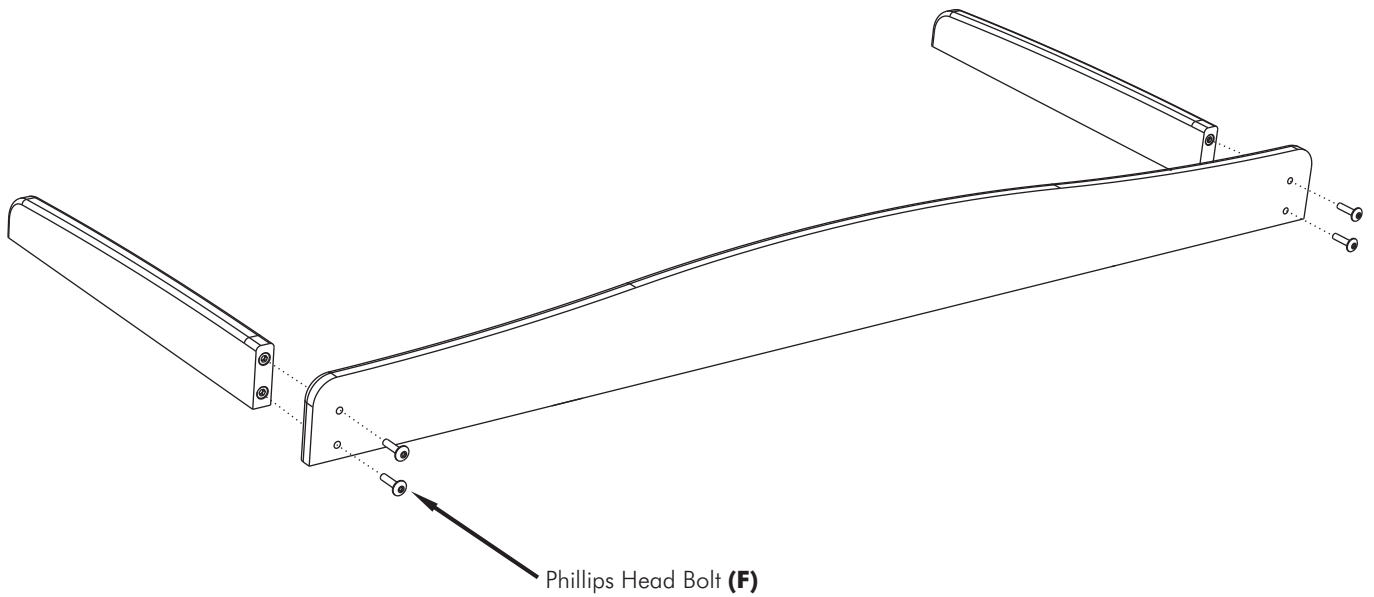

## Step 3

- A.** If you are using a changing pad, secure it to the combo using the straps as instructed by the pad manufacturer.
- B.** Center the galley rail on the top, then screw the wood screws (G) through the holes on the mounting plates and into the combo.

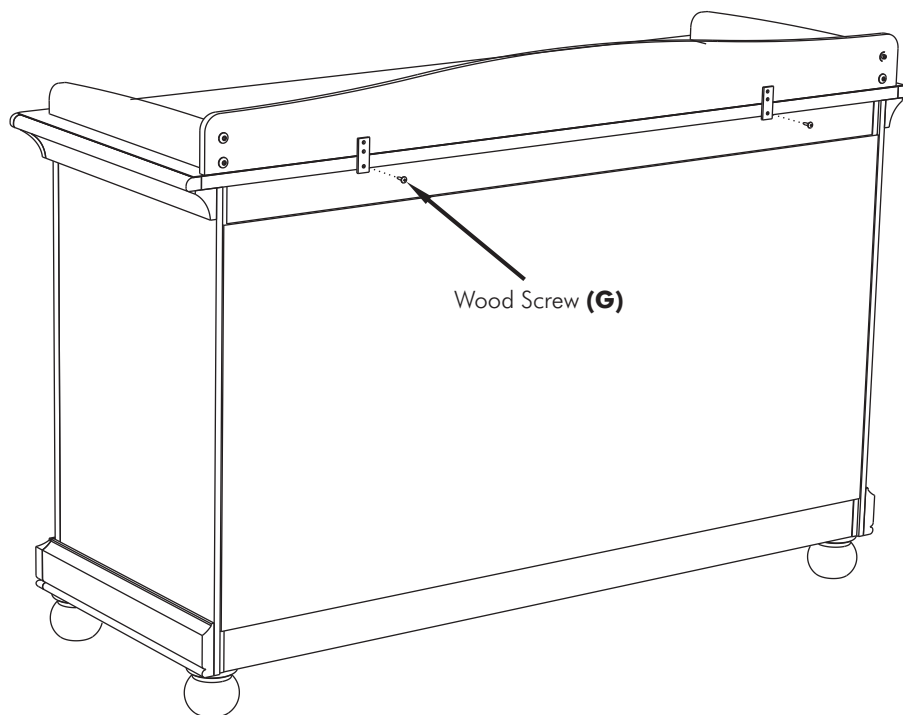

## Step 4

**A.** Insert the shelf tabs (D) into the holes on the inside of the door, and carefully lower the shelf (C) onto the tabs.

**B.** If desired, you can screw  $\frac{1}{2}$ " long wood screws (not included) through the holes in the bottom of the shelf tabs into the bottom of the shelf to prevent the shelf from being accidentally removed.

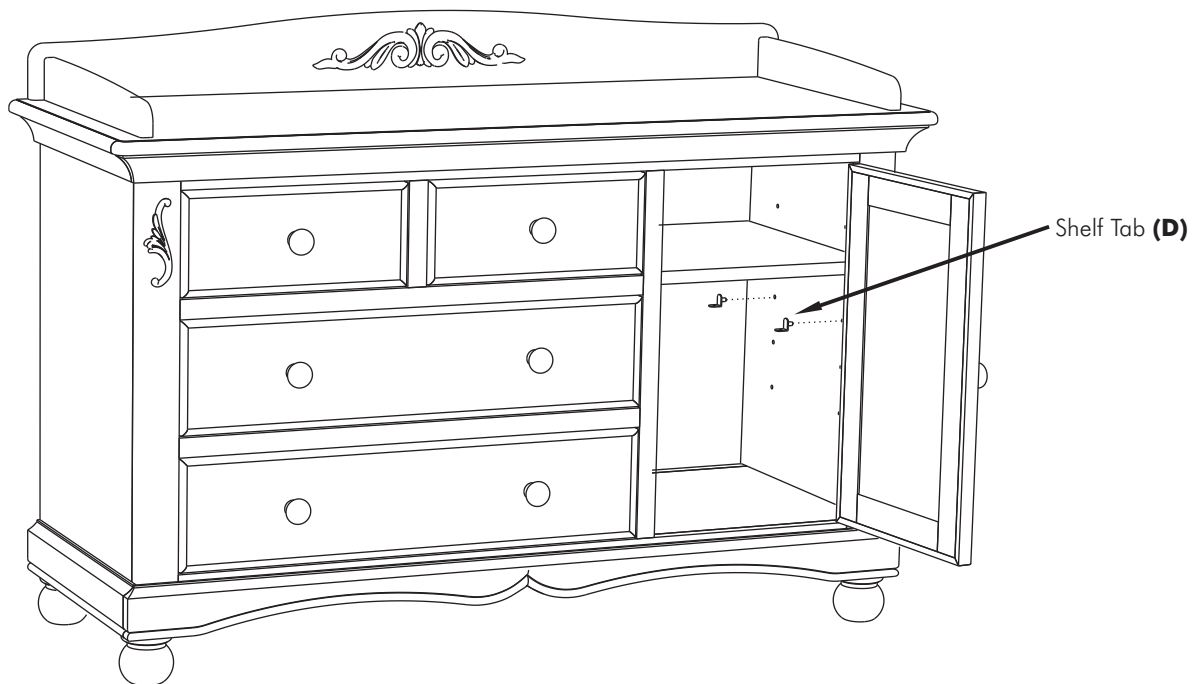

# H Hart Furniture

**635 N. Billy Mitchell Rd., Ste. B  
Salt Lake City, UT 84108  
Phone: 1-908-719-4707**

December 23, 2005