

# *B* Bedford Baby



## **Assembly Instructions Lily Dressing Combo**



## **WARNING: FALL HAZARD**





- **TO PREVENT DEATH OR SERIOUS INJURY, ALWAYS KEEP CHILD WITHIN ARM'S REACH.**
- THIS PRODUCT IS NOT INTENDED TO BE USED AS A CHANGING TABLE UNLESS EQUIPPED WITH AN APPROVED CHANGING PAD THAT MEETS ASTM F2388-06. USE OF THE PRODUCT WITHOUT THIS MAY RESULT IN DEATH OR SERIOUS INJURY TO YOUR CHILD FROM FALLING.
- THE MAXIMUM WEIGHT OF THE OCCUPANT MAY NOT EXCEED 30 LBS. (13.6 kg).
- THE CHANGING PAD MAY NOT EXCEED 44 IN. (1115 mm) IN LENGTH OR 18 IN. (455 mm) IN WIDTH.
- THE CHANGING PAD **MUST** BE SECURED TO THE CHANGING SURFACE FOLLOWING THE PAD MANUFACTURER'S INSTRUCTIONS.
- READ ALL INSTRUCTIONS BEFORE USE OF THE CHANGING TABLE OR THE CHANGING PAD.
- DO NOT USE CHANGING TABLE OR CHANGING PAD IF BROKEN.
- KEEP ALL INSTRUCTIONS FOR THE FUTURE.

**Congratulations on your purchase of a Bedford product. We take great pride in the quality and design of our furniture. The safety of your child is our highest priority. It is important that you read these instructions carefully and completely to ensure that this product functions as it was designed.**

**After opening the package, check to see that all the parts are present. If you think something is missing, please contact your retailer, and they can arrange to have the missing parts quickly replaced. You can also contact us directly, by calling 1-973-305-0444, or emailing [support@westwoodbaby.com](mailto:support@westwoodbaby.com).**

**If any aspect of these instructions is unclear, please contact your retailer or Bedford Baby for assistance.**

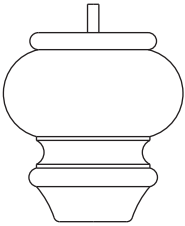
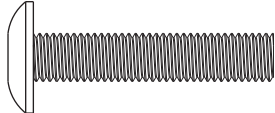
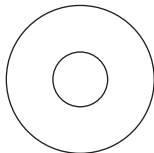
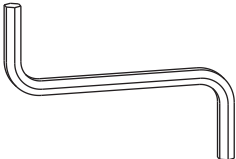
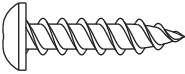
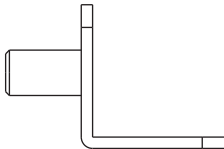
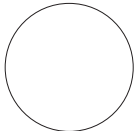
## Parts Included in Package:

<b>A</b> Galley Rail Back 	<b>B</b> 2 x Galley Rail Side 	
<b>C</b> Foot 	<b>D</b> 4 x Allen Head Bolt 	<b>E</b> 4 x Nylon Washer 
<b>F</b> Allen Wrench 	<b>G</b> 6 x Wood Screw 	<b>H</b> 4 x Shelf Tabs 
<b>I</b> 4 x Felt Pads 	<b>J</b> Shelf 	<b>K</b> Angled Bracket 

## Step 1

- A.** Unpack all the components from the packaging.  
The feet are located inside the combo.
- B.** Screw the feet into the base.

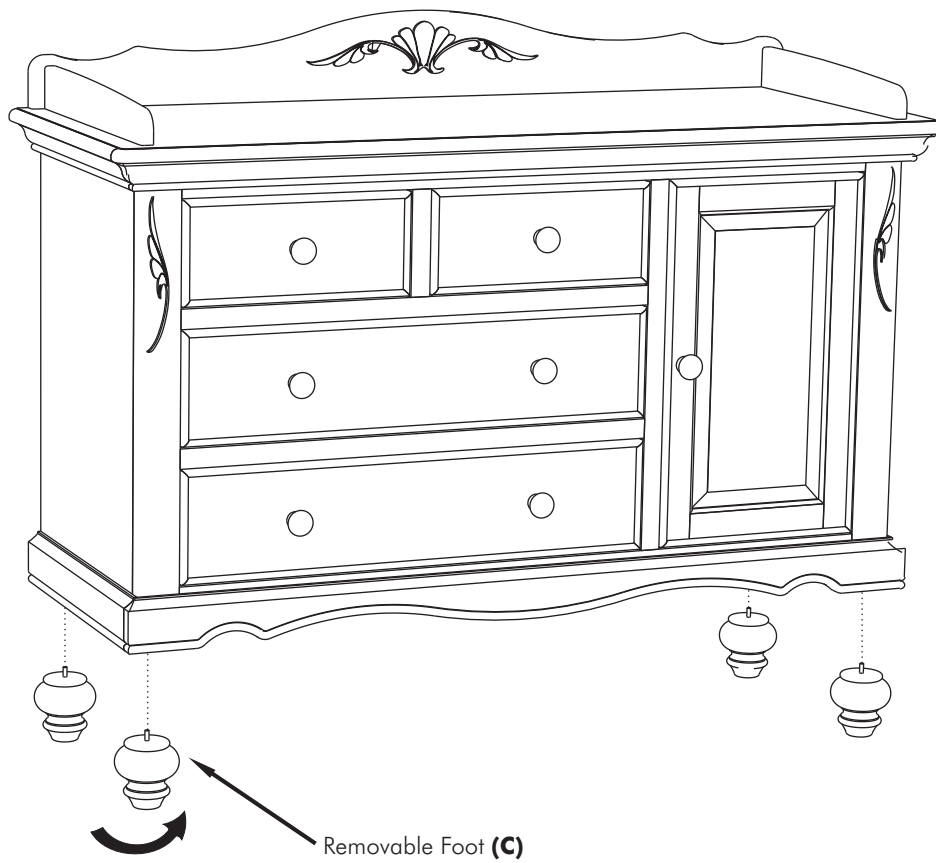

## Step 2

- A.** Align the holes in the galley rail sides (B) with the holes in the galley rail back (A).
- B.** Place a nylon washer (E) onto a bolt (D), then thread it through the hole. Tighten securely using the allen wrench. Do not overtighten. Repeat for the other hole.
- C.** Repeat for the other galley rail side.
- D.** Attach the angled brackets (K) to the back of the galley rail by screwing the wood screws (G) into the pre-drilled holes. The brackets must be attached so that the angle points in the direction shown.

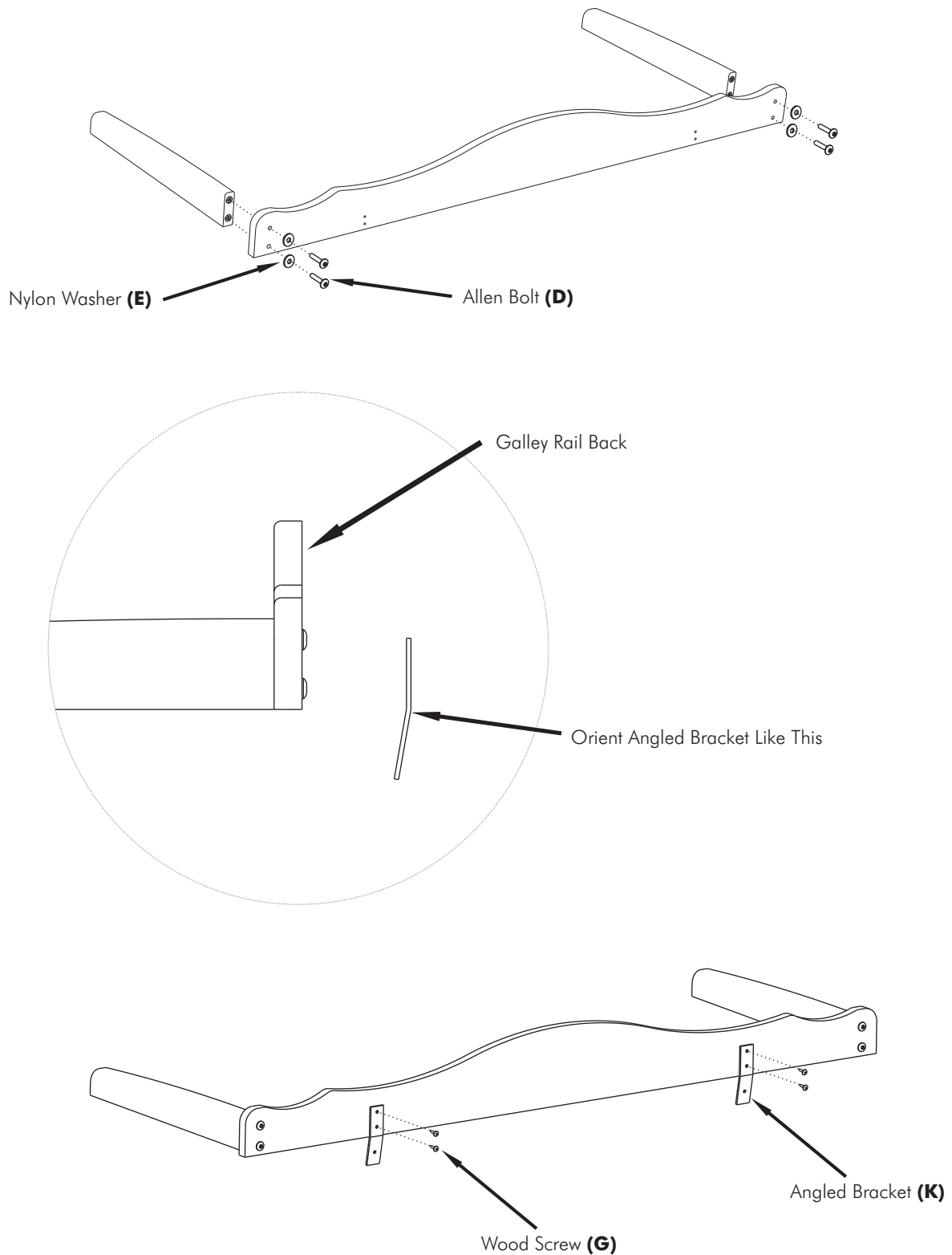

## Step 3

Center the galley rail on the top, then screw the wood screws (G) through the holes on the brackets and into the combo. The screws should go into the panel below the top. There are no pre-drilled holes in the combo, but the wood screws will self tap into the wood with the use of a moderate amount of force applied while turning the screw.

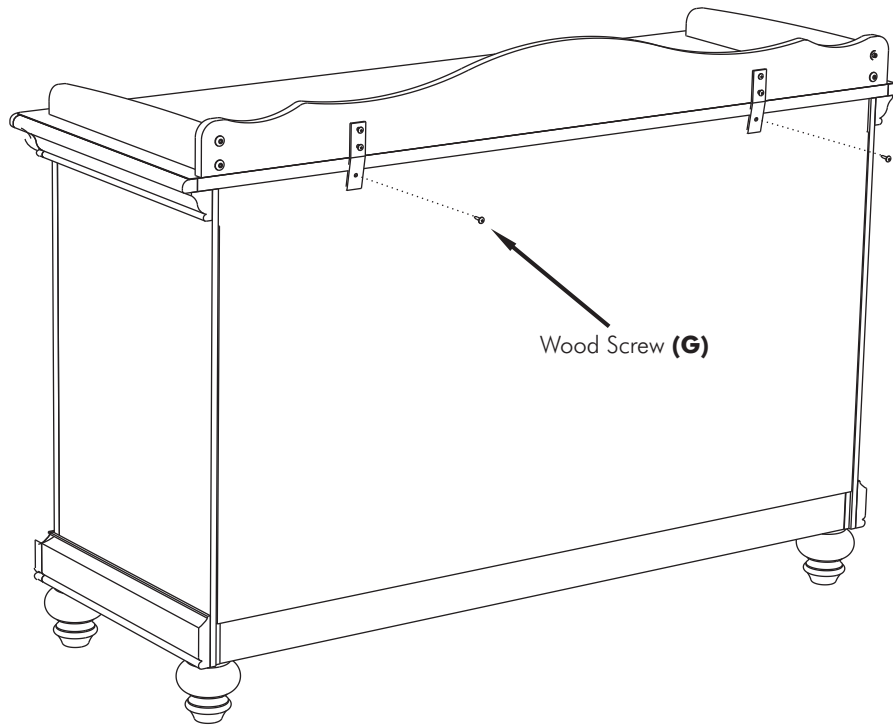

## Step 4

- A.** Stick the felt pads (I) onto the shelf tabs (H) so the tabs don't scratch the shelf.
- B.** Insert the shelf tabs into the holes on the inside of the door, and carefully lower the shelf (J) onto the tabs.
- C.** If desired, you can screw wood screws through the holes in the bottom of the shelf tabs into the bottom of the shelf to prevent the shelf from being accidentally removed.



*B* Bedford Baby

635 N. Billy Mitchell Rd., Ste. B  
Salt Lake City, UT 84116 USA  
Phone: 1-973-305-0444  
support@westwoodbaby.com